

RA3

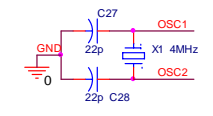
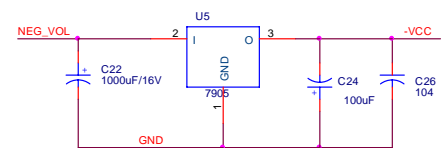
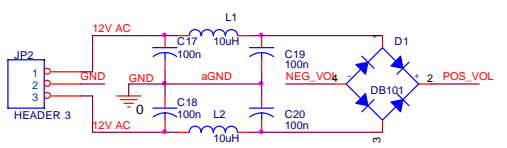
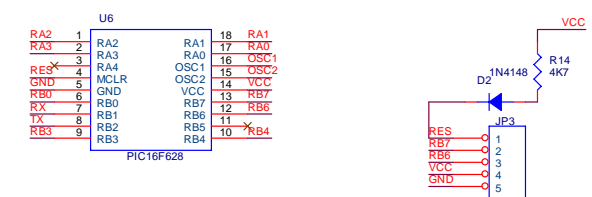
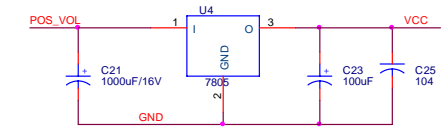
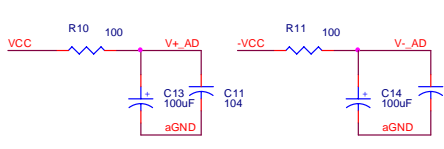
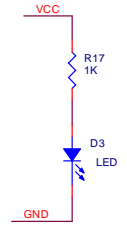
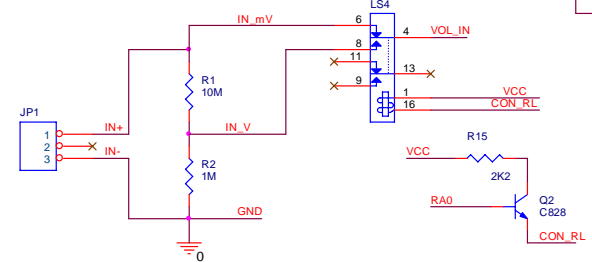
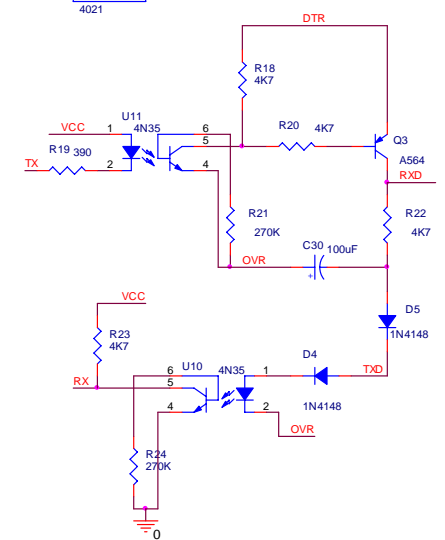
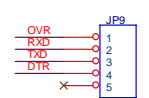

Title		<Title>
Size	Document Number	Rev
CustomDoc		
Ng.X.Thanh		
Date:	Thursday, April 07, 2005	Sheet 1 of 1