

Title			
MACH DAU VAO VA TAO XUNG CUA/BO TAO XUNG DAU VAO			
Size	Document Number	NG.X.THANH	Rev
Custom	<Doc>	<Rev Code>	
Date:	Sunday, February 27, 2005	Sheet	1 of 1

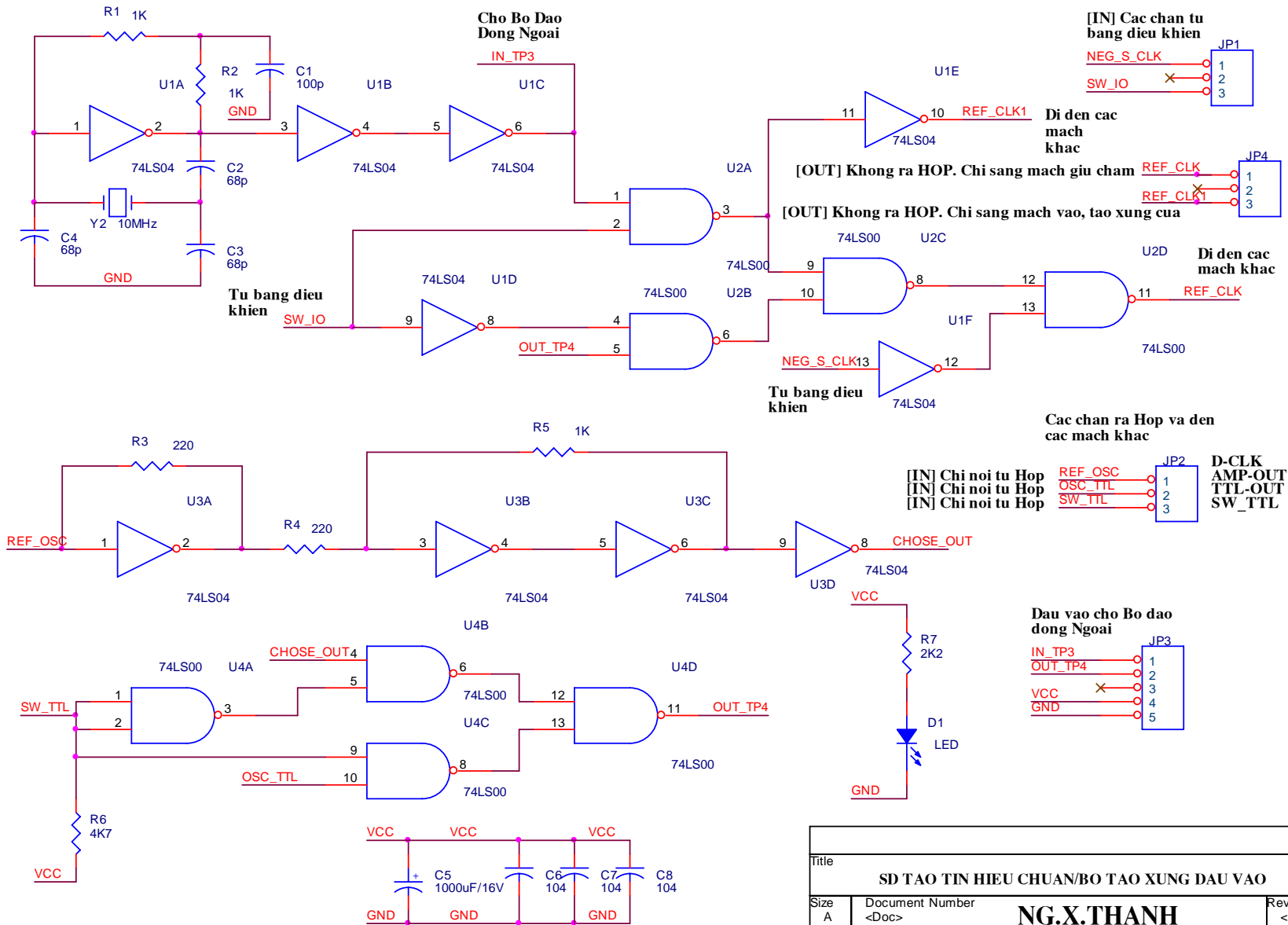

Title		
SD TAO TIN HIEU CHUAN/BO TAO XUNG DAU VAO		
Size A	Document Number <Doc>	Rev <Rev Code>
NG.X.THANH		
Date: Sunday, February 27, 2005	Sheet 1 of 1	

[IN] 3 chan DK tu PIC va 2 chan tu Bo tin hieu chuan va Bo DK

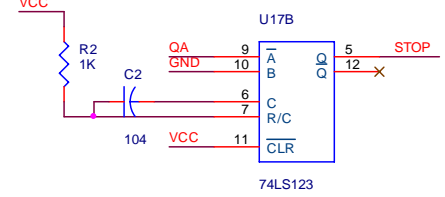
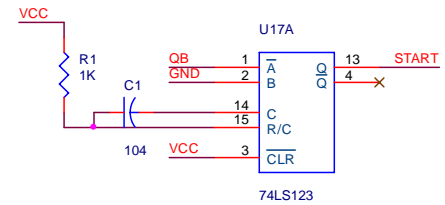
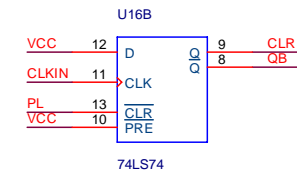
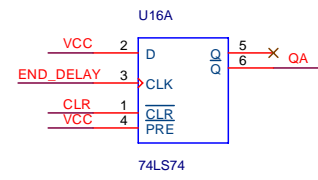
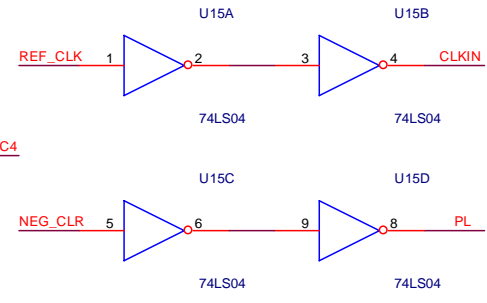
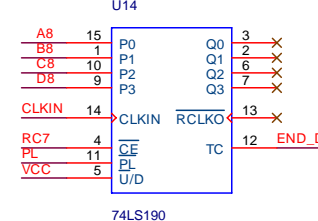
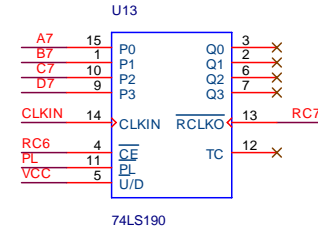
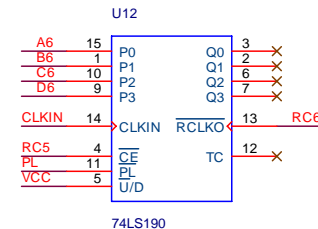
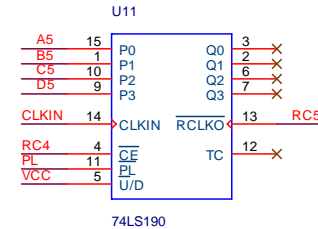
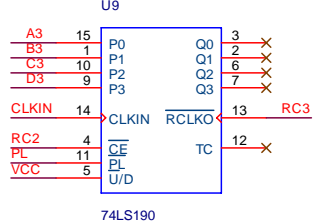
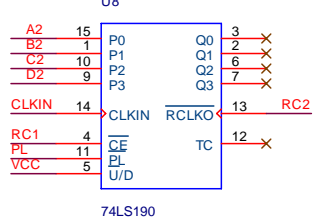
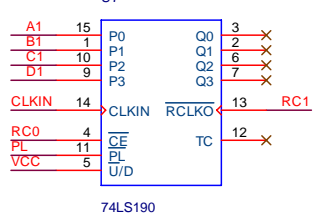
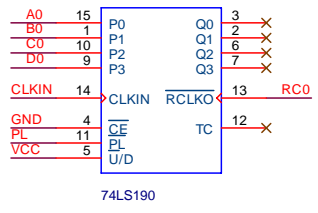
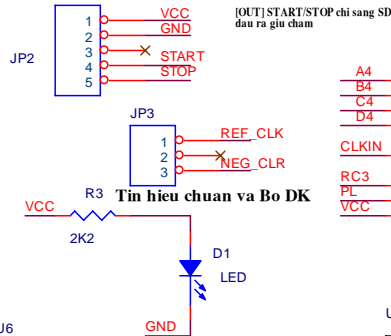
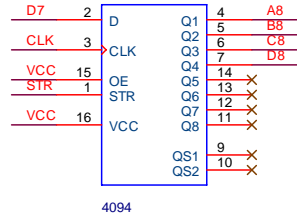
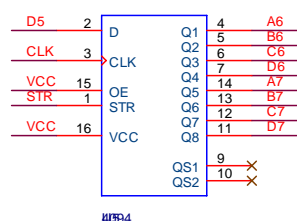
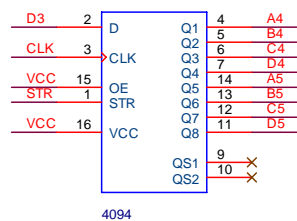
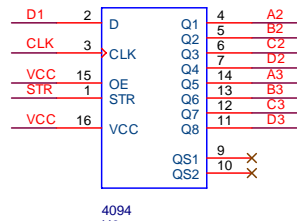
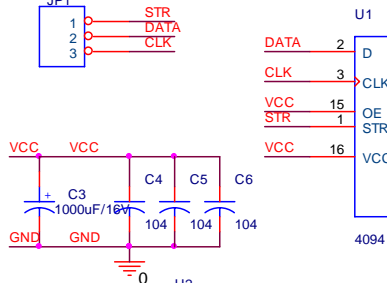

Title		
SD Giu cham/Bo tao xung giu cham		
Size	Document Number	Rev
Custom	<Doc>	
NG.X.THANH		
Date:	Sunday, February 27, 2005	Sheet 1 of 1

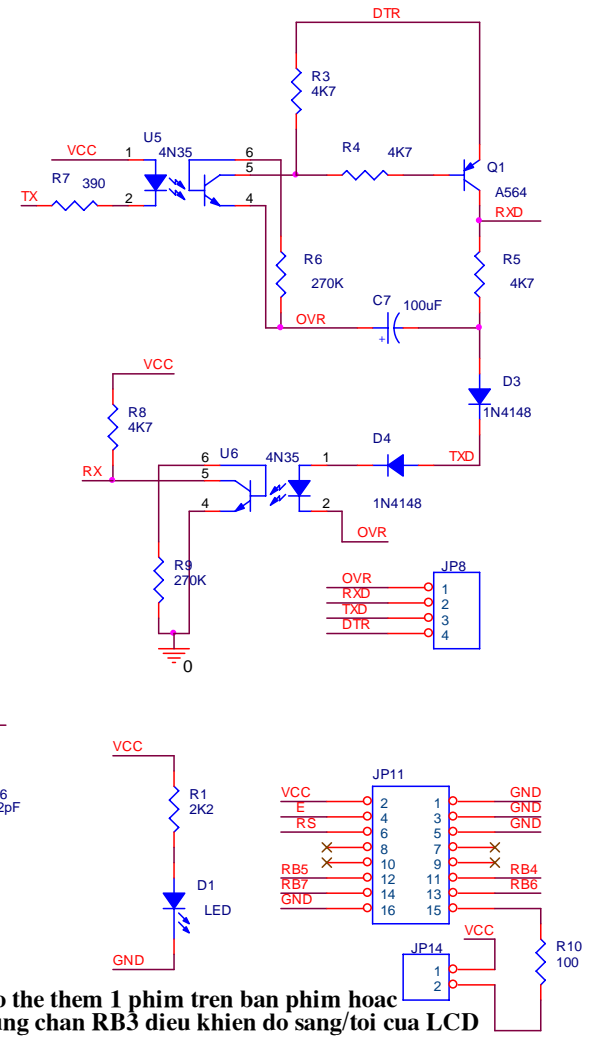
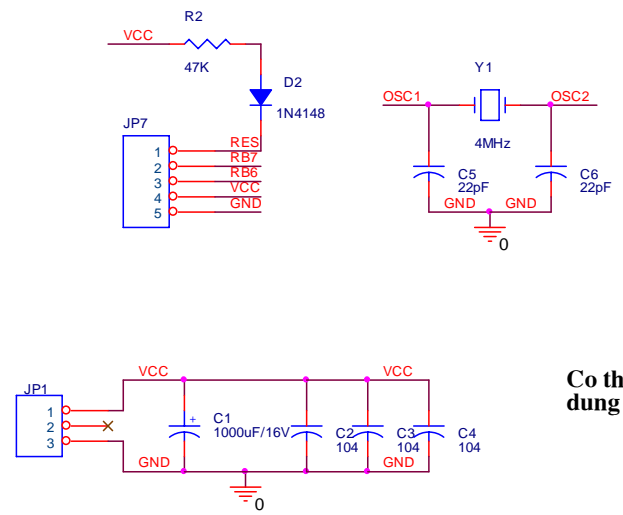
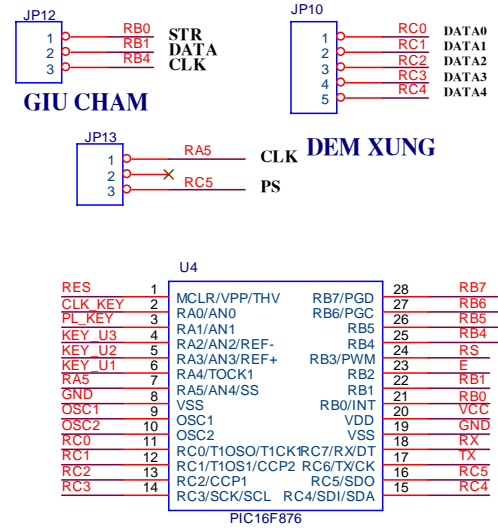
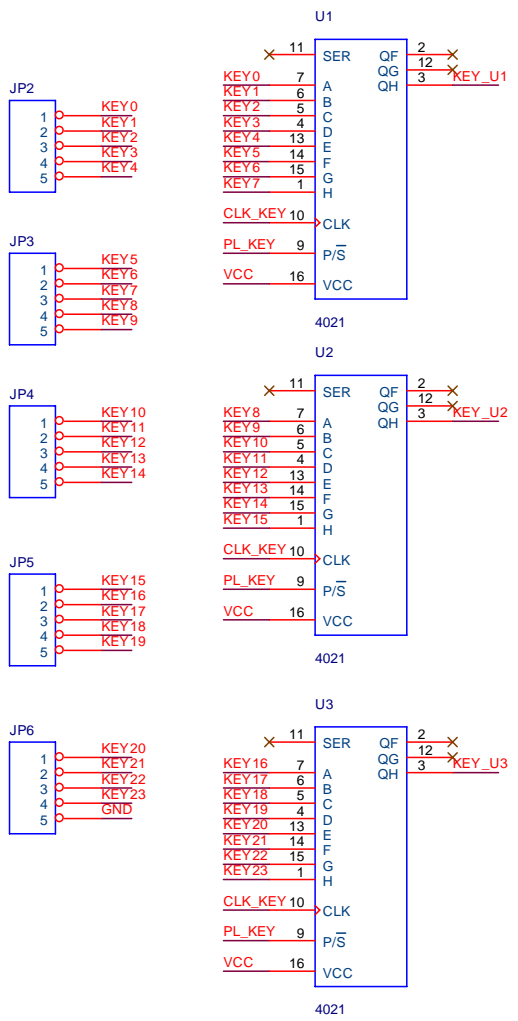

Co the them 1 phim tren ban phim hoac dung chan RB3 diu khien do sang/toi cua LCD

Title			
BO XU LY CHINH			
Size	Document Number	Rev	
Custom:Doc>	NG.X THANH		<Rev Code>
Date:	Sunday, February 27, 2005	Sheet	1 of 1

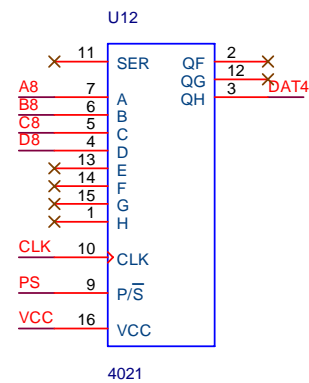
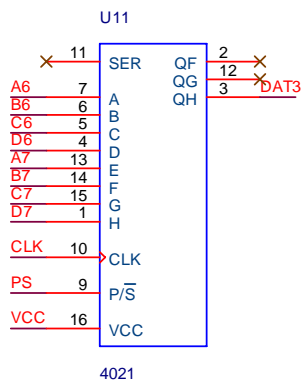
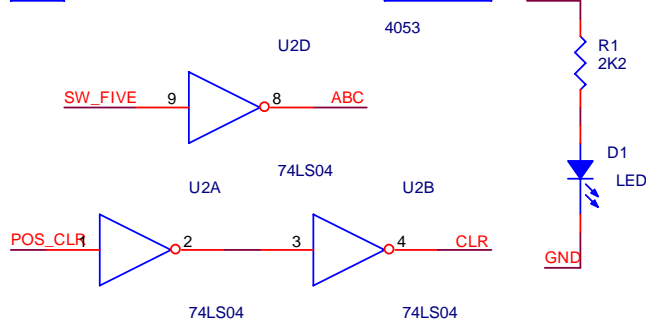
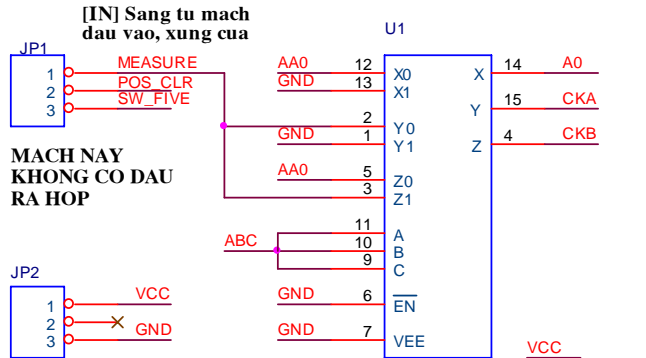

Cac chan noi voi PIC

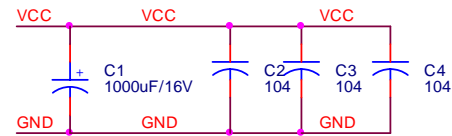
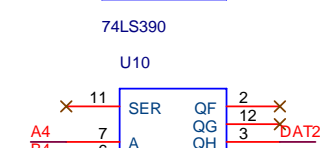
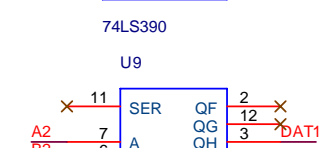
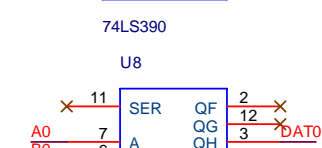
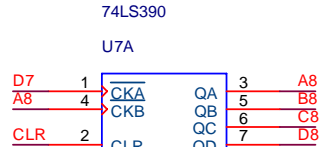
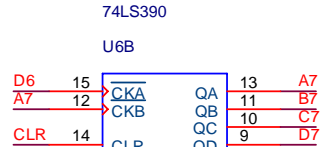
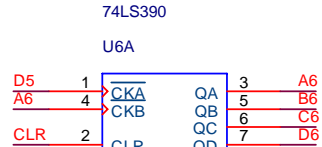
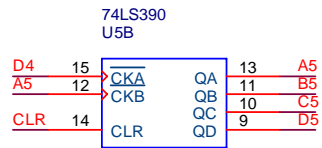
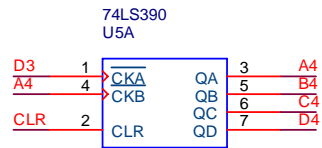
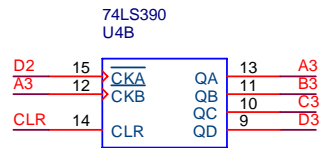
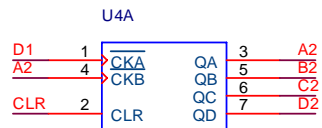
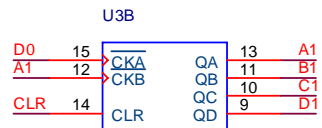
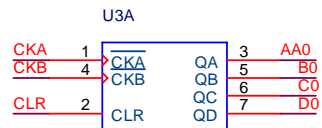
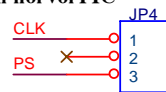
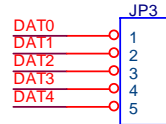

Title		
SO DO DEM XUNG/BO DEM XUNG		
Size A	Document Number <Doc>	Rev <Rev Code>
NG.X.THANH		
Date: Friday, May 14, 2010	Sheet 1	of 1

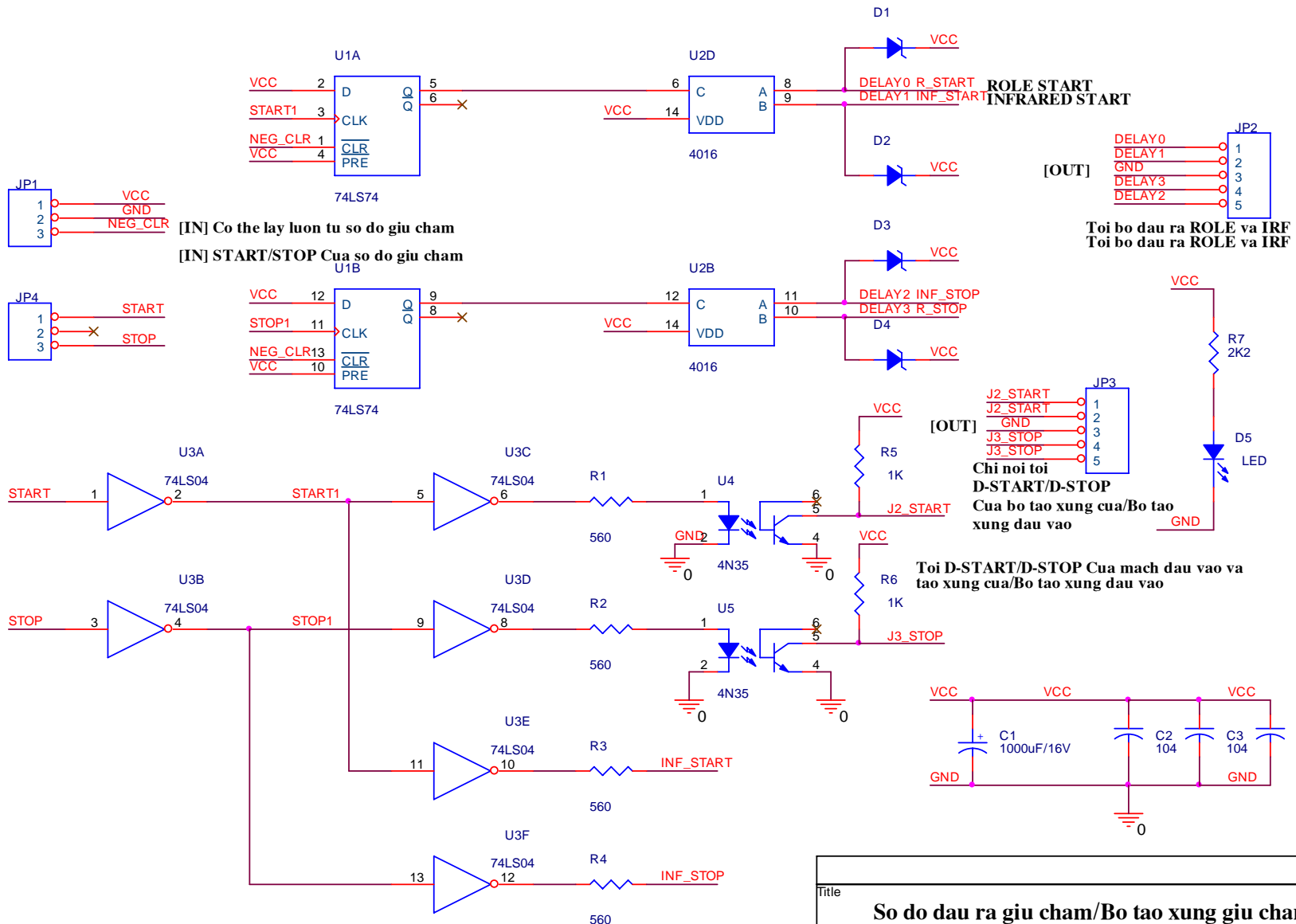

Title		
So do dau ra giu cham/Bo tao xung giu cham		
Size A	Document Number <Doc>	Rev <Rev Code>
NG.X.THANH		
Date: Tuesday, March 01, 2005	Sheet 1 of 1	

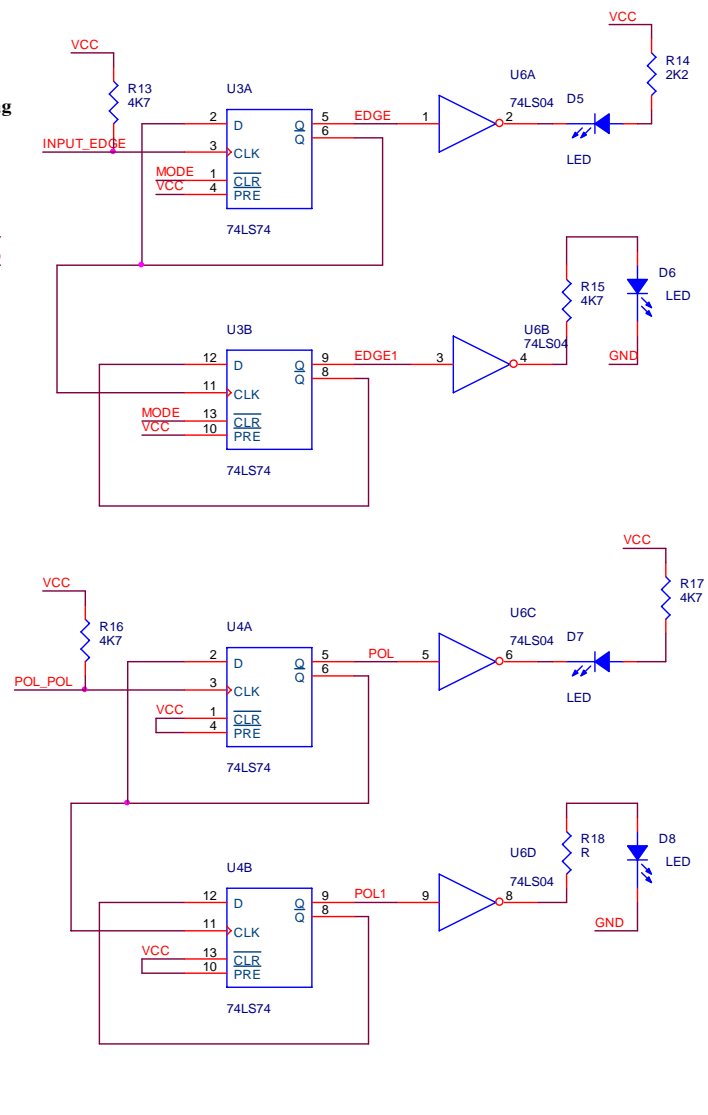
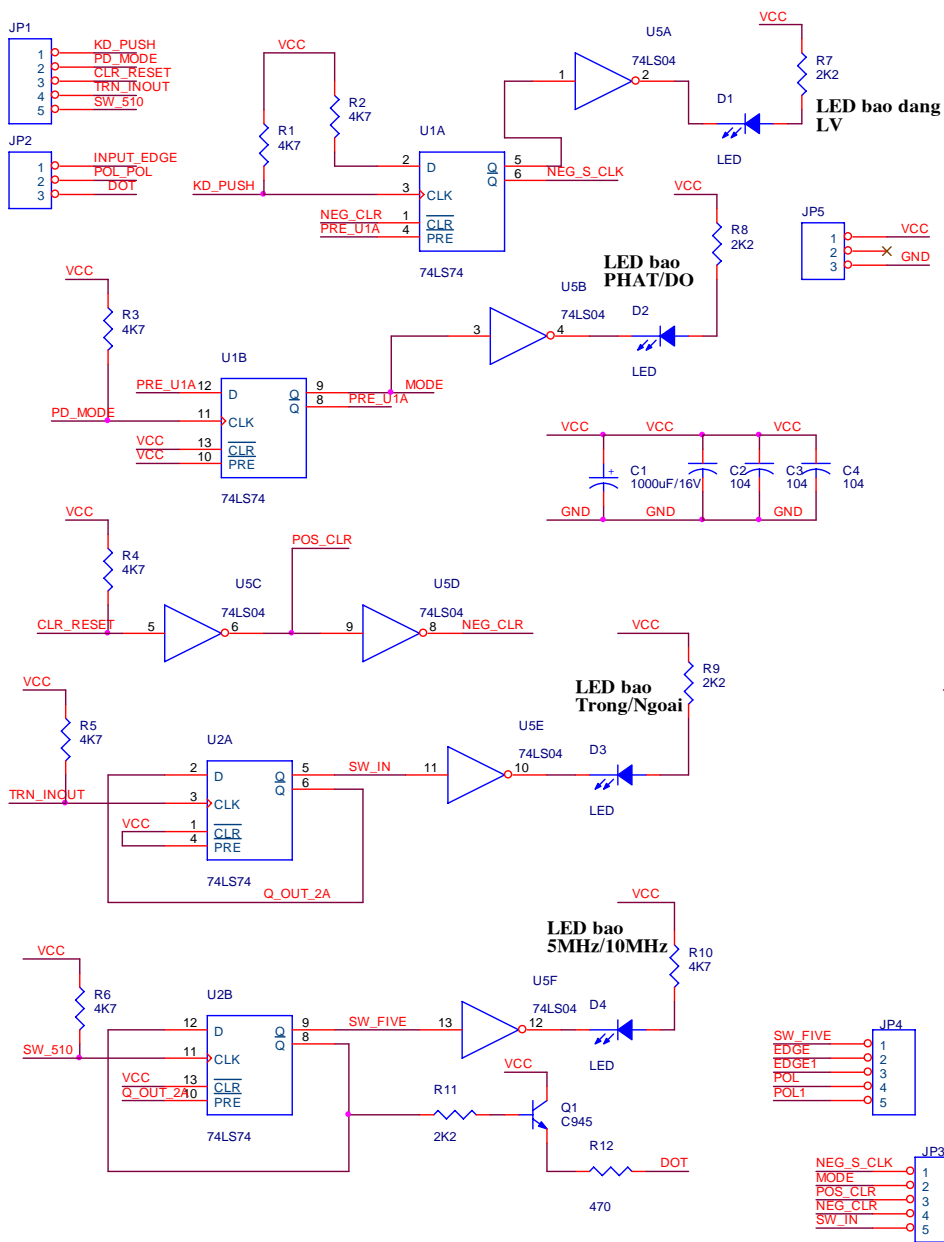

Title			SO DO HIEU THI CAC CHE DO		
Size	Document Number	NG.X.THANH		Rev	<Rev Code>
Date:	Friday, May 14, 2010	Sheet	1	of	1

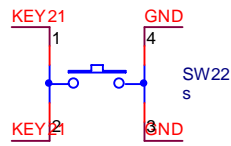
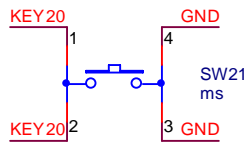
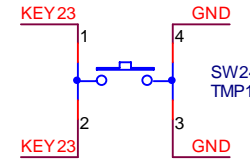
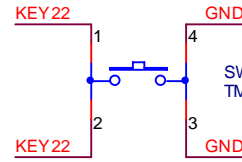
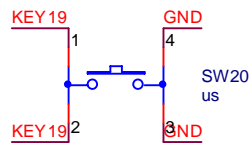
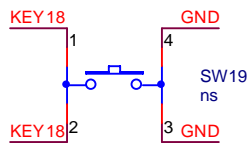
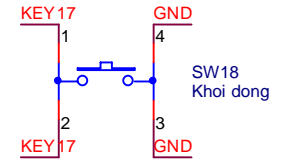
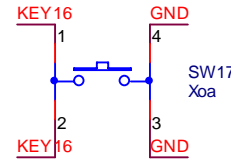
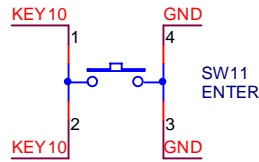
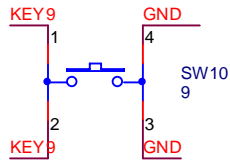
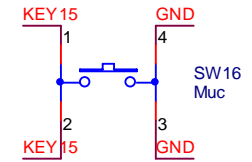
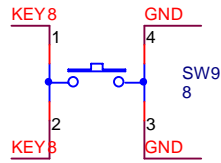
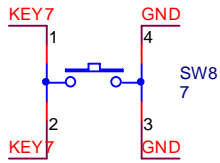
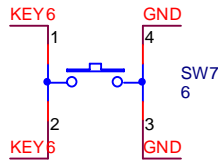
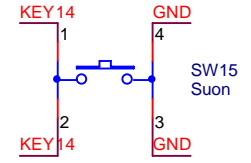
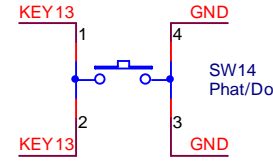
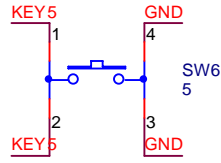
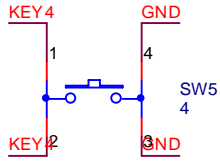
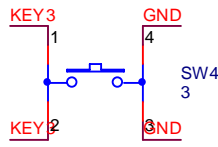
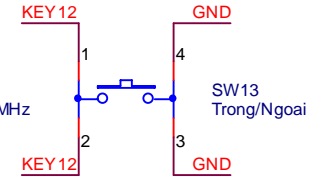
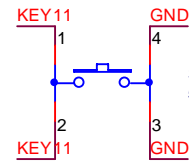
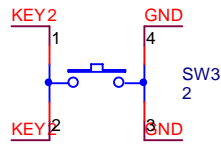
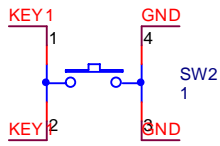
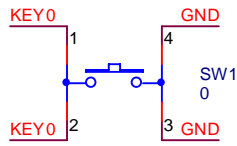
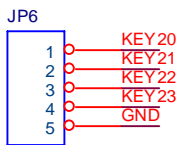
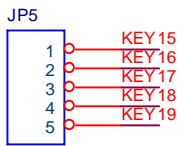
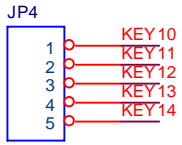
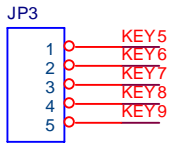
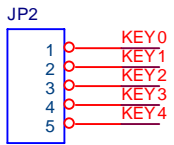

Title		
<Title>		
Size	Document Number	Rev
A	<Doc>	
Ban Phim		
Date:	Saturday, February 26, 2005	Sheet 1 of 1